



PLATINUM
PRO PLUG-IN
Nissan 350Z
Z33
(HT055016)
QUICK START GUIDE



LIMITED WARRANTY

Lockin Pty Ltd trading as Haltech warrants the Haltech™ Programmable Fuel Injection System to be free from defects in material or workmanship for a period of **12 months** from the date of purchase.

Proof of purchase, in the form of a bill of sale or receipted invoice, which indicates that the product is within the warranty period, must be presented to obtain warranty service. Lockin Pty Ltd trading as Haltech suggests that the purchaser retain the dealer's dated bill of sale as evidence of the date of retail purchase.

If the Haltech™ Programmable Fuel Injection System is found to be defective as mentioned above, it will be replaced or repaired if returned prepaid along with proof of purchase. This shall constitute the sole liability of Lockin Pty Ltd trading as Haltech.

To the extent permitted by law, the foregoing is exclusive and in lieu of all other warranties or representations, either expressed or implied, including any implied warranty of merchantability or fitness. In no event shall Lockin Pty Ltd trading as Haltech, be liable for special or consequential damages.

DISCLAIMER

Haltech will not be held responsible for any damage caused by the incorrect installation or tuning of this product. It is the installers responsibility to ensure the wiring connections and pinouts match that of the vehicle the unit is being installed into.

Haltech has taken all care to make sure the connections match the specified vehicles listed, but variations in wiring and connections on vehicles can occur and therefore this should be checked BEFORE the unit is installed.

Haltech highly recommends installation and tuning of this product is to be carried out by a professional, with an understanding on installing and tuning engine management systems.

Misuse of this product can destroy your engine.

WARNING

This ECU is designed and sold for Racing use only. Using this product for street / road use may be prohibited by law. Please check with your local vehicle authority before using this product.

GENERAL INSTALLATION WARNING

Avoid open sparks, flames or operation of electrical devices near flammable substances. Always disconnect the battery cables when doing electrical work on your vehicle.

Do not charge the battery with a 24 Volt truck charger or reverse the polarity of the battery or any charging unit. Do not charge the battery with the engine running as this could expose the ECU to an unregulated power supply that could destroy the ECU and other electrical equipment.

All fuel system components and wiring should be mounted away from heat sources, shielded if necessary and well ventilated. Disconnect the Haltech ECU from the electrical system whenever doing any arc welding on the vehicle by unplugging the wiring harness connector from the ECU.

After completing the installation, make sure that there are no fuel leaks, and no wiring left un-insulated in case a spark or short-circuit occurs and causes a fire. Also make sure that you follow all proper workshop safety procedures. If you're working underneath a jacked-up car, always use safety stands!

PLATINUM Pro Plug-in Nissan 350Z / Z33

Quick Start Guide

Congratulations on purchasing a Haltech Engine Management System. This *fully programmable Plug and Play* product opens the door to virtually limitless performance modification and tuning of your vehicle. Programmable systems allow you to extract all the performance from your engine by delivering precisely the required amount of fuel and ignition timing that your engine requires for maximum output under all operating conditions.

This quick start guide will walk you through installation of the Platinum Pro ECU into a vehicle. This guide is accompanied by the full service manual located on the software CD provided with the ECU that you or your tuner will need to refer to before completing your installation and configuration. The Manual is included in the software which can be downloaded from the Haltech website www.haltech.com

Supported Vehicles

The Platinum Pro Plug-in Nissan 350Z / Z33 ECU supports the following:

- Nissan 350Z / Z33 (2003 - 2006)
- Nissan Skyline V35 (2003 - 2006)
- Infinity G35 (2003 - 2006)

** Does not support VQ35HR*

Platinum Pro Plug-in Nissan 350Z / Z33 Kit Includes

- Haltech Platinum Pro Plug-in ECU
- Vacuum hose for connection of Internal MAP sensor to intake manifold
- USB Cable
- Software CD
- Quick Start Guide

Loaded Basemap

Your Platinum Pro Plug-in has been programmed with a basemap to suit a Nissan 350Z / Z33 running a VQ35DE engine using the **internal ECU MAP sensor**.

Alternatively, a basemap using the OEM MAF Sensor as a load reference is available in the following folder for you to upload into your ECU:

C:\Users\<username>\Documents\Haltech\ECUMaps\Nissan\Z33

Please ensure you load, modify and check the corresponding basemap for your application before attempting to start the vehicle.

ECU Installation

To install your new Platinum Pro Plug-in to your Nissan 350Z / Z33, please follow the procedures below.

Please Note the following installation photos are based on a Nissan Skyline V35 (JDM)

You will require the following tools

- Screwdrivers Phillips No 2 ,
- Socket set with 10mm socket

1. Locate your factory ECU. This will be located behind the glove compartment. Remove the glove compartment by removing the 6 screws holding it in place. Unclip the glove compartment light and the Airbag wiring from the glove compartment. (**Do not disconnect the Air Bag Wiring**) Remove glove compartment.



Figure 1 – ECU is located behind the glove compartment

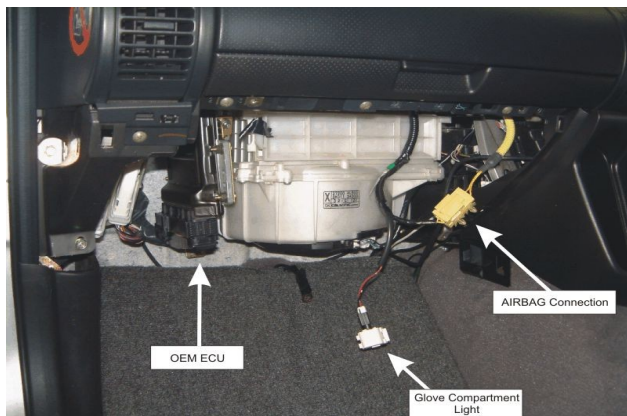

Figure 2 – Left hand footwell showing glove compartment removed

2. Disconnect the OEM ECU from the main wiring harness, by raising the locking lever. Remove the 2 x 10mm nuts securing the OEM ECU to the vehicle, Remove the ECU and mounting bracket assembly.



Figure 3 – OEM ECU on Mounting bracket

3. Remove the 3 x 10mm nuts securing the OEM ECU to the mounting bracket, Remove the ECU
Secure the Haltech ECU to the Haltech mounting kit using the provided captive nuts and screws. Attach the assembled ECU and mounting to the original OEM mounting bracket using the original 3 x 10mm nuts. as seen below



Figure 4 – Platinum Pro Plug-in ECU mounted on OEM mount

4. If the internal MAP sensor is to be used install the supplied vacuum line from the engine intake manifold to the barb on the rear of the Haltech ECU. Connect the USB cable and auxiliary connector to the ECU, and re-install into the vehicle.



Figure 5 – Haltech ECU Installed in OEM Location

5. Re install the glove compartment.



Figure 6 – Glove compartment re-installed

6. Calibration of the Electronic Throttle

Before trying to start the vehicle the Electronic throttle **MUST** be calibrated. Calibration of the throttle is achieved by using the Haltech ECU Manager ETC Calibration wizard located in the Advanced Tab within the Main setup page. The process to Calibrate the Electronic Throttle is outlined below.

- Install ECU into vehicle as described previously
- With the ignition switch turned on, connect the to the ECU via Haltech ECU Manager Software using the USB cable provided
- Navigate to the Main Setup page by pressing F4 or by using the Setup / Main Setup Tabs
- Go to the Advanced setup page via selecting the icon on the left of the main setup page
- Select Electronic Throttle Tab to display the Haltech Electronic Throttle Calibration wizard, we are now ready to calibrate the throttle. To begin the calibration process select the **Start >>** button
- The Haltech Calibration wizard will now guide you though the Electronic Throttle Calibration.

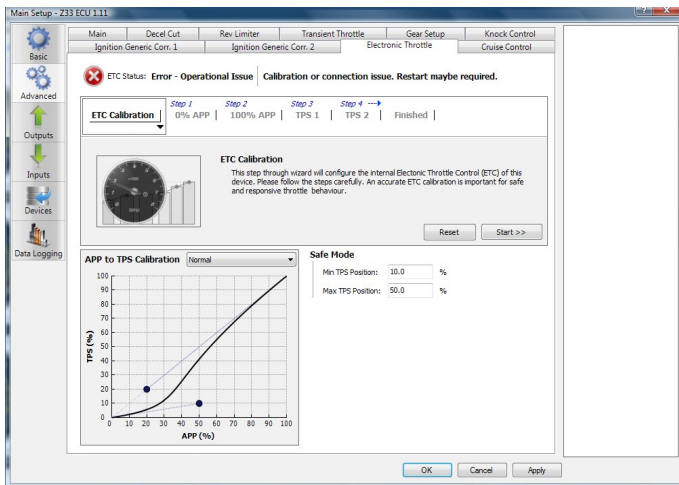

Figure 7- Main Setup Page showing Advanced Menu ETC Calibration Wizard

Calibration Steps

Step 1: 0% Accelerator Pedal Position (APP)

Ensure that the accelerator pedal is NOT depressed and click the calibrate button

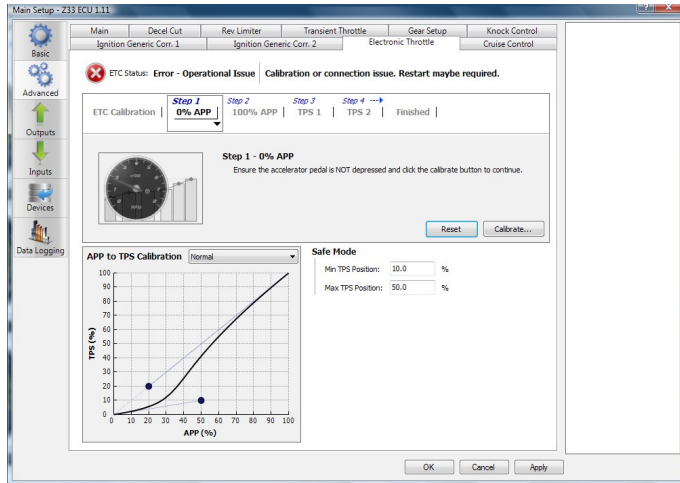

Figure 8 – 0% APP Successful calibration display

Step 2: 100% Accelerator Pedal Position (APP)

Fully press the accelerator pedal. Continue to hold the pedal in this position and click the calibrate button

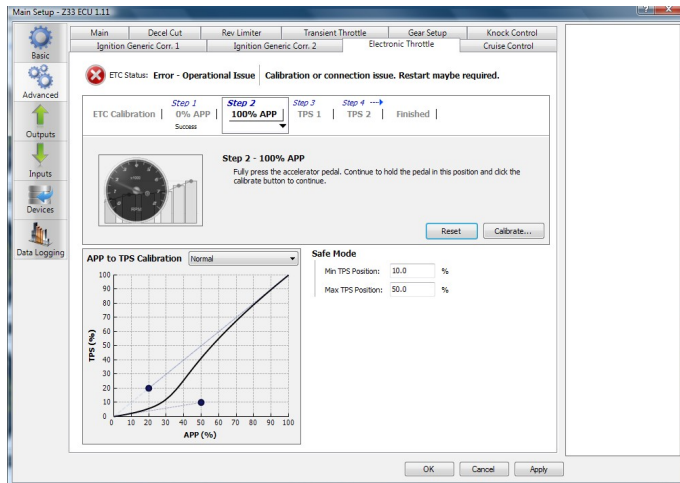

Figure 9 – 100% APP Successful Calibration display

Step 3: Throttle Position Sensor 1 (TPS 1)

Release the accelerator pedal to a non-pressed state. Ensure that all electronic throttles are connected and click 'Calibrate' to continue

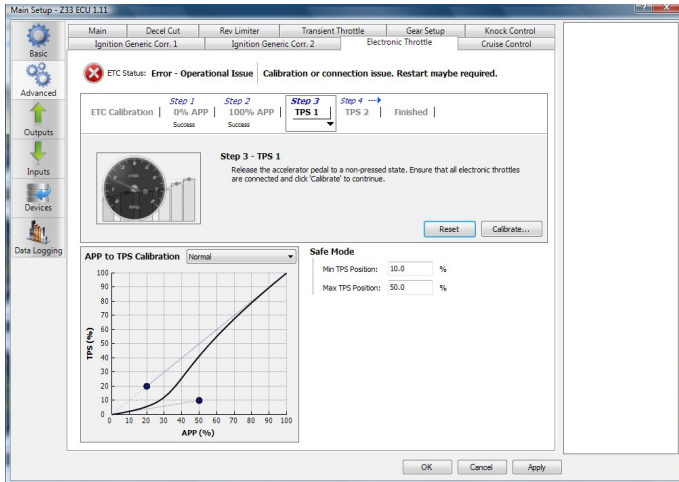

Figure 10 – TPS 1 Calibration Success

Step 4: Throttle Position Sensor 2 (TPS 2)

In Twin throttle applications the Electronic Throttle Calibration wizard will proceed to calibrate the TPS 2 automatically. This is not required with this application and will be skipped automatically by the wizard

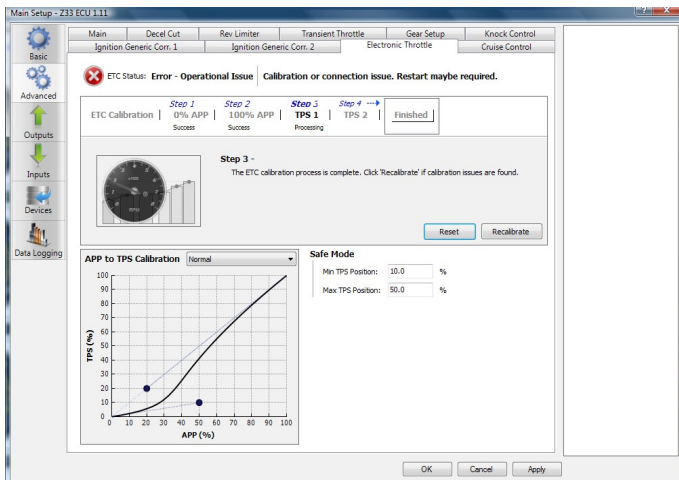

Figure 11 – TPS 2 Calibration Success

When successfully calibrated the ETC Status will change to “Online / Calibrated”
 Once calibrated its now time to start your engine.

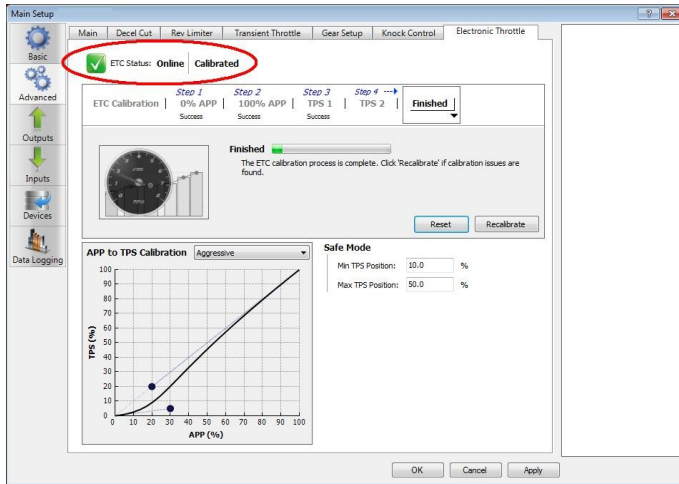

Figure 12 – Successful Calibration Indication

- With the engine started and running its time to tune. This is best achieved by your nearest engine tuner. See the listing of Haltech dealers on our website to find the one closest to you.

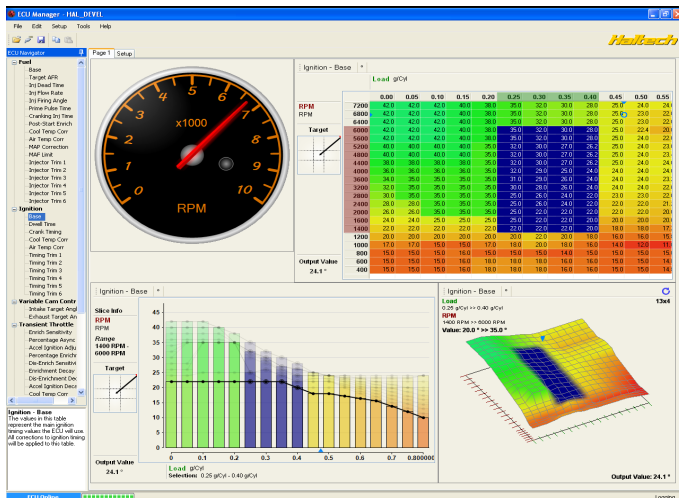

Figure 13 – ECU Manager tuning page

ECU Manager Software

ECU Manager software is used for setup, calibration and diagnostics and can be found on the CD supplied with this unit or downloaded from the Haltech website www.haltech.com

Minimum System Requirements

Operating System:	Windows 2000 SP4 / XP / Vista / Windows 7
Processor Speed:	1GHz
RAM:	256 Mb
Video Card:	128MB graphics card with 3D acceleration
USB:	1.1
Hard Drive Space:	250Mb
Minimum Screen Resolution:	1024 x 768 pixels

Installing ECU Manager

Installing ECU Manager onto your PC is performed similar to any other Windows software package. Installation is outlined below to ensure correct installation:

- 1.** Insert the CD-ROM into your PC's CD-ROM drive. The CD should automatically launch into the Haltech Browser. If the CD does not run automatically double click on the "My Computer" icon on the desktop, double click on the Haltech icon (CD- ROM drive) to start the browser software.
- 2.** The Browser will display the disclaimer and you will need to agree to the terms stated before allowing to progress. Read the Disclaimer and click on AGREE if you agree.
- 3.** Now you will be able to access all the information contained on the CD
- 4.** To download the Platinum Software, click on the Platinum Series ECU Manager Link. You will be prompted to install the software. Click "Install" to install ECU Manager and the Data Log viewer.
- 5.** Follow the software prompts and install the software.

With your programming cable (USB) attached to your ECU and the other end connected to your laptop, power up the ECU by turning your key to IGN. Start the programming software on your PC and go online with the ECU.

ECU Manager / ECU Manuals

Detailed manuals can be found in the software by pressing your F1 key or by selecting the Help tab located at the top left of the screen

ECU Manager File Extensions

When ECU manager saves the map from the Haltech ECU, it saves the map with a Haltech specific file extension.

The File extension can be broken down as follows:

Example File : xxxx.hz33-111

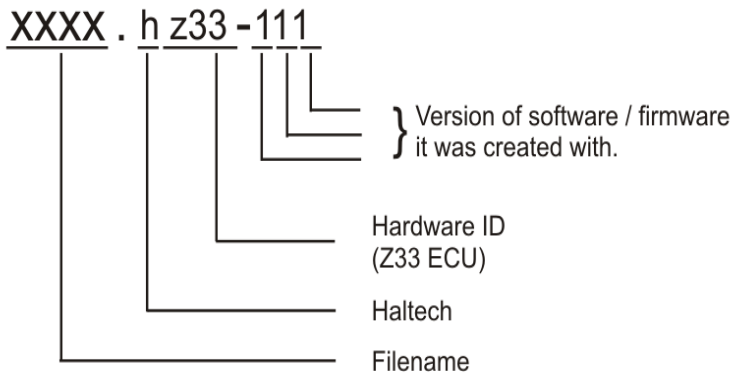

Later map versions cannot be loaded into ECU's with earlier firmware versions.

ECU Manager will upgrade earlier map versions when loading into ECU's with later firmware versions.

ECU Manager upgrades maps between versions where equivalent settings are available. However, new settings not in the original map, will be substituted with values from the new version's default map.

WHENEVER ECU MANAGER CONVERTS YOUR ECU MAP, YOU SHOULD ALWAYS CHECK YOUR MAP SETTINGS TO ENSURE THAT ALL THE APPROPRIATE SETTINGS HAVE BEEN CONVERTED CORRECTLY.

Rear Auxiliary Connector

The Platinum Pro Plugin Series allows further expansion of your ECU by the Rear Auxiliary Connector.

The Rear Auxiliary connector allows you access to:

- 1 Additional Digital Pulsed Input (DPI)
- 2 Additional Digital Pulsed Outputs (DPO)
- 2 Additional Digital Switched Outputs (DSO)
- 4 Additional Analogue Voltage Inputs (AVI)

These extra Inputs / Outputs can be used to:

Fit additional sensors. (eg MAP, Temperature and Flex Fuel)

Control additional devices via relays

Control additional solenoids directly (eg Aftermarket Boost Control solenoid)

The Rear Auxiliary harness is available as an optional extra. (HT040003)



Pin #	Wire Colour	Connection
1	O	+5V
2	Y	AVI1 (MAP)
3	O/B	AVI2
4	B/W	SIGNAL GROUND
5	V/B	DPO1
6	V/BR	DPO2
7	GY<SHD>	DPI1
8	R	+13.8V
9	O	+5V
10	GY	AVI 3
11	GY/B	AVI 4
12	B/W	SIGNAL GROUND
13	V/R	DSO1
14	V/O	DSO2
15	-	-
16	R	+13.8V

* <SHD> Denotes shielded cable

Figure 14 - Rear Auxiliary Harness Connector and Pin-out

Digital Pulsed Input (DPI)

Digital Pulsed Inputs are capable of accepting pulsed input information such as for a road speed sensor. These inputs measure the time periods between the pulses and can process this information to provide quantities such as road speed.

One additional input can be connected using the Optional Rear Auxiliary Harness (HT040003)

Digital Pulsed Outputs (DPO)

Digital Pulsed Outputs are capable of producing pulsed waveforms with varying duty and frequency. DPO's can be used to control various devices such as thermo-fans, shift lights, bypass air control valves, boost control solenoids etc.

When a Digital Pulsed output is activated by the ECU the output will switch to ground. Solenoid valves and shift lights etc can be run directly from the output, however high current devices such as thermo-fans and additional fuel pumps must be activated through a relay. This way the DPO is only switching a relay and not a high current draw device.

Two additional outputs can be connected using the Optional Rear Auxiliary Harness (HT040003)

Digital Pulsed Outputs are limited to 800mA Max current draw.

Digital Switched Outputs (DSO)

Digital Switched Outputs are capable of switching to ground

DSO's can be used to control relays in an on / off state only.

Two additional outputs can be connected using the Optional Rear Auxiliary Harness (HT040003)

Digital Switched Outputs are limited to 800mA Max current draw.

Analogue Voltage Inputs (AVI)

Analogue Voltage Inputs accept variable voltage inputs from 0V to 5V. These inputs can also accept switch inputs that change between two different voltage levels.

The On Voltage and Off Voltage define what the thresholds are between the On and Off states. The Voltage can be viewed as a channel in the software to determine the thresholds for a switched input.

Two additional sensors or switched inputs can be connected using the Optional Rear Auxiliary Harness (HT040003)

Wire connections

When using crimp connectors ensure that the correct crimping tool is used – if in doubt do a pull test on a crimp connector, the wire should break before the wire pulls out of the crimp. Terminal soldering can weaken a connection and should only be used as a last resort. If solder joints are used, ensure joints are well isolated from movement as solder joints are prone to fracture.

When splicing 2 wires it is preferable to use a crimp splice – again if using a solder joint, ensure joint is limited in its range of possible movement as solder joints are prone to fracture. Always use heat-shrink sleeving to insulate wires.

The Haltech CAN Network

The Haltech CAN network allows for simple and effective expansion in ECU capability and functionality without having to go to the trouble of wiring in a whole new computer.

Expansion is made possible by the addition of multiple expansion devices that communicate to the main ECU via a Control Area Network (CAN).

Installation time and costs are kept to a minimum as all expansion devices are powered up from the main ECU via the pre-terminated connection cable that comes with each expansion device.

Simply connect the device directly to the 8 pin CAN connector on the rear of the ECU or connect using an optional Haltech CAN Hub (order as part # HT059990) if multiple expansion devices are required).

Each expansion device is pre-programmed with a unique ID code which allows it to be recognised on the network and work correctly first time every time.

For current available expansion devices please go to our website at www.haltech.com



Figure 15 – Haltech ECU connected to a Racepak Dash

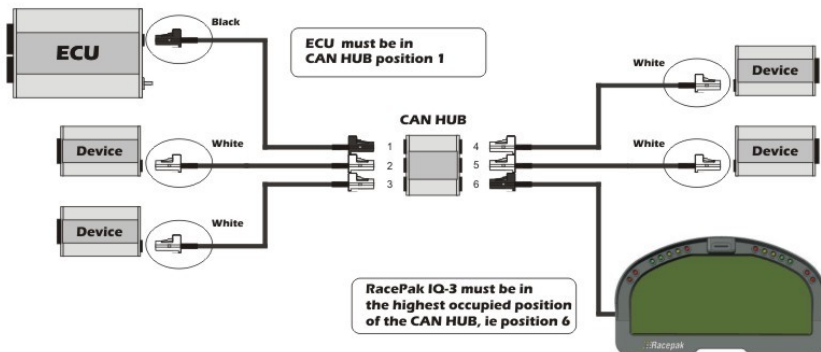
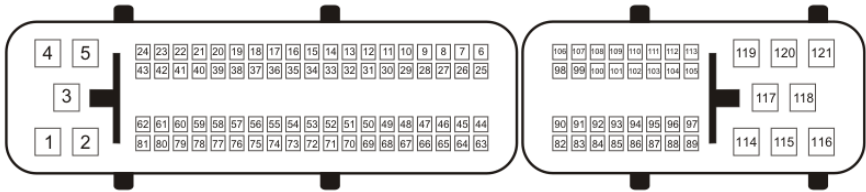

Figure 16 – Haltech ECU connected to 5 Auxiliary CAN based devices

ECU PINOUT



LOOKING INTO ECU CONNECTOR

1	ECM ground	41	Injector No.4	81	Ignition signal No.2
2	Heated oxygen sensor 1 heater(bank 2)	42	Injector No.2	82	Sensor ground(APP sensor 1)
3	Throttle control motor relay power supply	43	-	83	Sensor ground(APP sensor 2)
4	Throttle control motor (Close)	44	-	84	-
5	Throttle control motor (Open)	45	EVAP canister purge volume control solenoid valve	85	-
6	Heated oxygen sensor 2 heater(bank 2)	46	-	86	CAN communication line
7	-	47	Sensor power supply(Throttle position sensor)	87	-
8	Exhaust valve timing control solenoid valve(bank 2)	48	-	88	-
9	Exhaust valve timing control solenoid valve(bank 1)	49	Sensor power supply(Refrigerant presre sensor)	89	-
10	Intake valve timing control solenoid valve(bank 2)	50	Throttle position sensor 1	90	Sensor power supply(APP sensor 1)
11	Intake valve timing control solenoid valve(bank 1)	51	Mass air flow sensor	91	Sensor power supply(APP sensor 2)
12	Power steering pressure sensor	52	-	92	-
13	Crankshaft position sensor(POS)	53	Exhaust eCVT position sensor(bank 1)	93	-
14	Camshaft position sensor(PHASE)(bank2)	54	-	94	CAN communication line
15	Knock sensor	55	Heated oxygen sensor 2 (bank 2)	95	-
16	Heated oxgen sensor 1(bank 2)	56	-	96	-
17	-	57	-	97	-
18	-	58	-	98	Accelerator pedal position sensor 2
19	-	59	-	99	ASCD steering switch
20	-	60	Ignition signal No.5	100	-
21	Injector No.5	61	Ignition signal No.3	101	Stop lamp switch
22	Injector No.3	62	Ignition signal No.1	102	PNP switch
23	Injector No.1	63	-	103	-
24	Heated oxygen sensor 1 heater(bank 1)	64	-	104	Throttle control motor relay
25	Heated oxygen sensor 2 heater(bank 1)	65	-	105	-
26	-	66	Sensor ground(Throttle position sensor)	106	Accelerator pedal position sensor 1
27	-	67	Sensor ground	107	-
28	-	68	Sensor power supply(Power steering pressure sensor)	108	ASCD brake switch
29	-	69	Throttle position sensor 2	109	Ignition switch
30	-	70	Refrigerant presre sensor	110	-
31	-	71	-	111	ECM relay (Self shut-off)
32	-	72	Exhaust eCVT position sensor(bank 2)	112	-
33	Camshaft position sensor(PHASE)(bank1)	73	Engine coolant temperature sensor	113	Fuel pump relay
34	Intake air temperature sensor	74	Heated oxygen sensor 2 (bank 1)	114	-
35	Heated oxygen sensor 1 (bank 1)	75	-	115	ECM ground
36	-	76	-	116	ECM ground
37	-	77	-	117	-
38	-	78	Sensor ground(Heated oxygen sensor)	118	-
39	-	79	Ignition signal No.6	119	Power supply for ECM
40	-	80	Ignition signal No.4	120	Power supply for ECM
41	Injector No.4			121	Power supply for ECM(Back-up)

Figure 17 – Platinum Pro Plug-in 350Z / Z33 ECU Pinout

Haltech™

ENGINE MANAGEMENT SYSTEMS



